

HITACHI

Customized comfort

Residential and light commercial applications

MINI SPLIT SYSTEMS

Cooling & Heating



**Your world
& Hitachi.**

Index

04	Introduction
12	Indoor Air Quality Features
18	Comfort Features
21	Control Features
24	Hitachi Mini-Split Residential Product Line
26	Features Comparison Chart
28	H300 Single-Zone System
30	H500 Single-Zone System
32	H700 Single-Zone System
34	M400 Multi-Zone System
44	Controllers
47	Controller Feature Comparison Chart
49	Support

Mini-splits solve big challenges

No small feat

Hitachi ductless systems deliver just the right amount of heating and cooling to every space while using no more energy than necessary.

Hitachi Mini-Split Systems are the ideal choice for applications that challenge traditional HVAC systems such as projects with varied loads and occupancy rates or cases where existing systems can't be modified to reasonably meet customer needs.

A wide portfolio of equipment means Hitachi Mini-Split Systems can be customized to meet the exact needs of your customers.





Quiet, efficient comfort

- High-efficiency, inverter-driven compressor modulates capacity to meet temperature requirements exactly.
- ECO mode automatically shifts the set temperature to reduce energy consumption.
- Unique human-sensing capability monitors activity and adjusts temperature accordingly.
- Indoor fan automatically adjusts speed for maximum comfort.
- Pre-heating system ensures indoor fan doesn't run until coil has warmed to prevent cool air from circulating when in heating mode.
- Sound pressure levels are as low as 27 dB(A).



Consistently efficient

Saving energy is something we should all be thinking about. We designed your air conditioner to think about it too, by intelligently analyzing the conditions in your home to deliver consistent comfort and energy efficiency.

Eco Mode operation

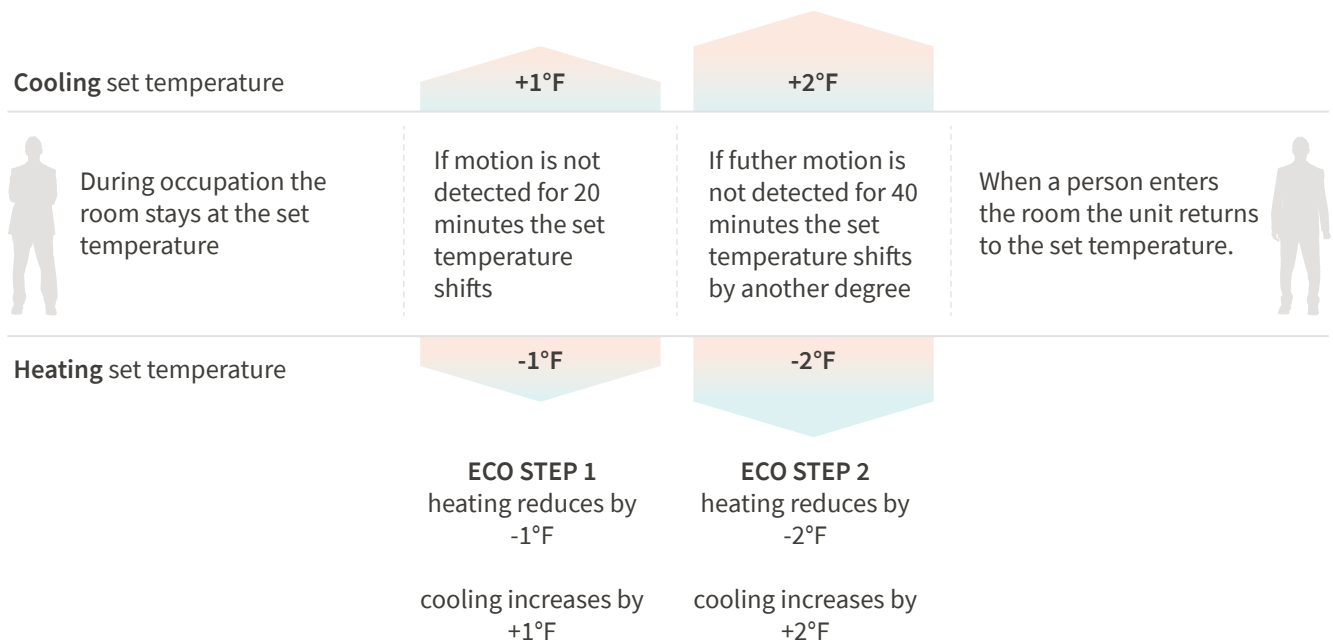

ECO Mode with human sensor detects the absence or presence of people in the room and adjusts temperature for comfortable cooling and energy savings.

Known for quality

Hitachi is recognized around the globe for superior products. The tradition of manufacturing excellence continues with the new mini-split line of equipment. Built to exacting standards in state-of-the-art facilities, Hitachi Mini-Splits provide comfort, energy savings, and years of worry-free performance. Advanced technology powers exceptional performance with features that promote comfort, health, convenience, and efficient performance.

MINI-SPLIT SYSTEMS



INTRODUCTION

Trusted for innovation

Designed to perform

Hitachi Mini-Splits feature the powerful Vector DC Inverter System which takes comfort and efficiency to a new level. The technology monitors and adjusts compressor rotation speed, cooling with maximum capacity at startup, then automatically slowing to optimum operating capacity. This provides smoother, more comfortable and energy-efficient performance and more reliable operation in unstable power conditions.

Inverter

Energy consumption (Efficient)

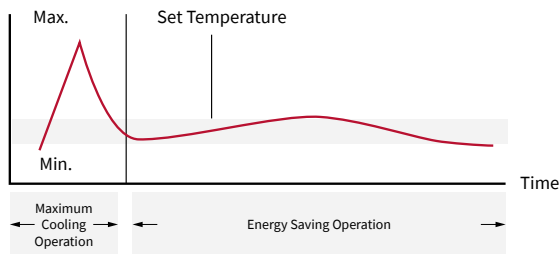

Vector DC Inverter technology saves energy by starting at maximum capacity then slowing and maintaining optimum capacity.

Energy savings

Ductless mini-split systems essentially eliminate the energy loss that occurs in conventional, ducted central systems. In addition, variable-speed compressors in outdoor units provide extremely high part-load efficiency, making Hitachi Mini-Split Systems an excellent choice for energy-conscious customers. A selection of heating and cooling options are available to meet the application's exact capacity and SEER requirements.

Non-Inverter

Energy consumption (Not Efficient)

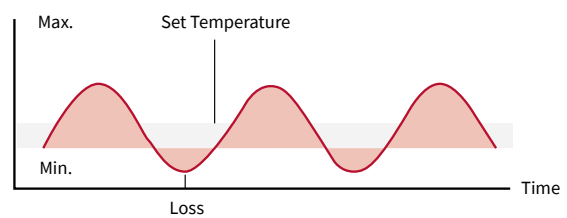

Traditional systems run through repeated on and off cycles, increasing energy consumption.

Built to last

Reliable performance requires durable materials. Outdoor units are constructed with metal casings that are both fireproof and rustproof. A special anti-corrosion coating lengthens condenser life, improves performance and durability, and reduces the need for maintenance — even in coastal environments.

MINI-SPLIT SYSTEMS



INTRODUCTION

Durability and safety

Fireproof electrical enclosure

meets the highest international manufacturing standards.



Indoor unit metal casing



Outdoor unit metal casing

Anti-corrosion Green Fin coating

lasts beyond the lifetime of a standard condenser.

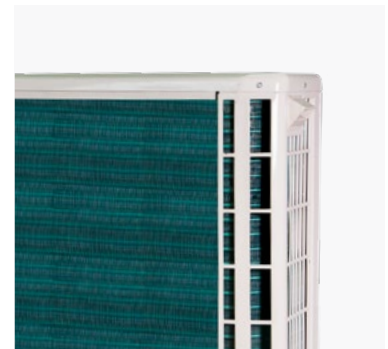
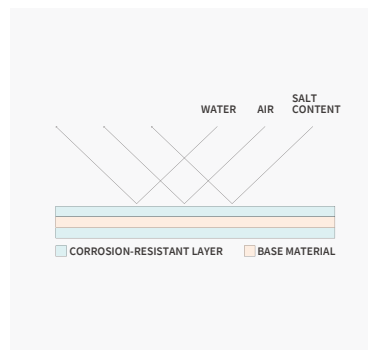

Anti-rust outdoor unit casing

reduces maintenance and protects unit.

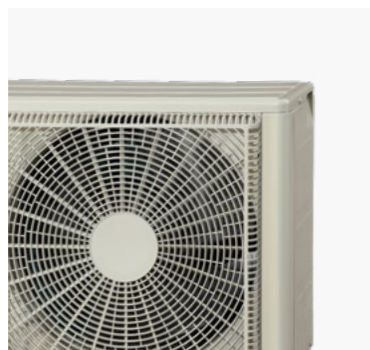



INDOOR AIR QUALITY FEATURES

Fresher air starts with a clean unit

Today, we are increasingly conscious of how the air in our homes affects our health and well being. Even with modern air conditioning systems, dust and bacteria accumulate inside indoor units and this can lead to reduced air quality and efficiency.



FrostWash™*

FrostWash is our latest self-cleaning technology. It works by freezing moisture inside the unit, capturing and then flushing away impurities that can build up over time.



Stainless Pre-Filter

The pre-filter is the first level of purification and protection when the air goes into the unit. It prevents large particles, such as hair, dust and allergens, from going into the indoor unit and causing damage. Please clean the pre-filter frequently to ensure smooth air flow. The pre-filter is manufactured from stainless, which is more durable, anti-bacterial, and easier to clean.



PM2.5 Air Purifying Carbon Filter

The active carbon filter provides a superior level of cleanliness. When the unit is in use for an hour, 70% of the large particles are removed from the room. After over 4.5 hours of continuous operation, 99%** of the particles have been filtered out. Not only does the active carbon filter remove microscopic particles larger than 2.5 µm, but it also has anti-VOC properties and deodorizes the room, leaving the air fresh, breathable, and clean.

* Please refer to page 26 for available features of each model.

** Tested by Hitachi Environmental Test Laboratory. Test method: Both "PM2.5 Air Purifying Carbon Filter" and "Stainless Pre-filter" applied on an indoor unit. Operation mode is set at high fan speed cooling mode with thermo off on RAS-VJ24CLT in a room with size of 25m³.



MINI-SPLIT SYSTEMS

CLEANING FEATURES

Components for clean air

Hitachi Mini-Splits promote a healthy environment — indoors and out. Multiple cleaning technologies contribute to a more hygienic indoor environment while energy-efficient vector DC inverters reduce energy consumption, contributing to a cleaner planet.

- 1 **Washable Detachable Front Panel**
- 2 **Stainless Pre-Filter**
- 3 **PM2.5 Air-Purifying Carbon Filter**
- 4 **FrostWash™**

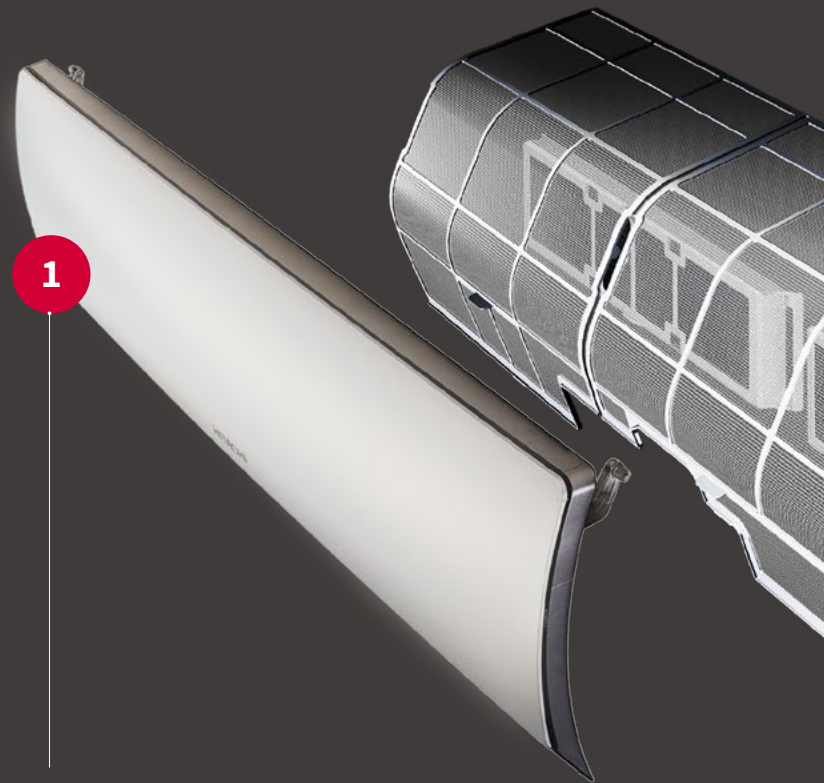

1. Washable Detachable Front Panel

The front panel of the unit can be easily removed for convenient cleaning and maintenance.

2. Stainless Pre-Filter

Durable and easy to clean, the pre-filter reduces bacterial growth by preventing large particles from entering the unit for cleaner, fresher-smelling air.

Unit shown for example purposes only.
Units available may differ by region.

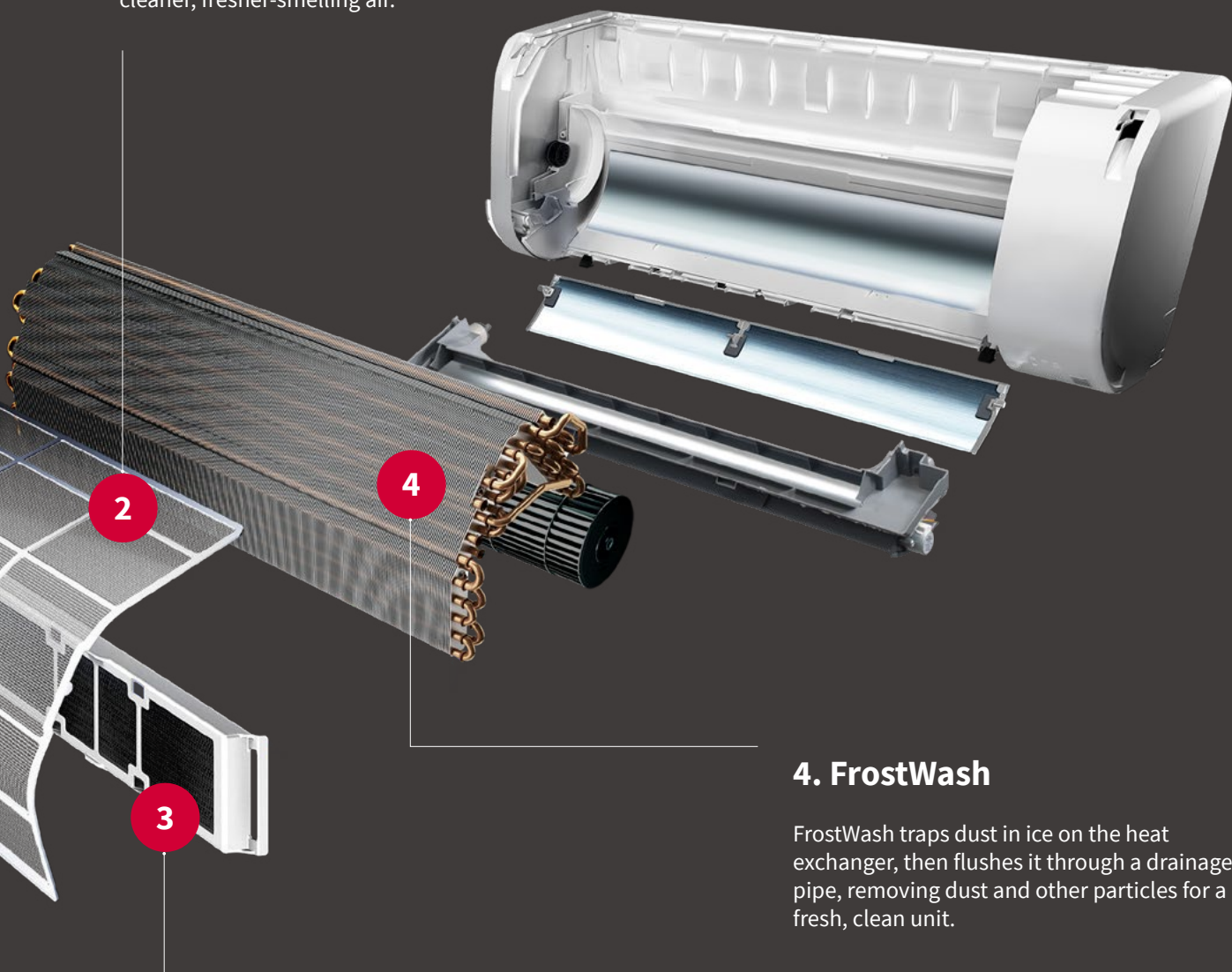

3. PM2.5 Air-Purifying Carbon Filter

The carbon filter keeps PM2.5 particles out of the air which can include bacteria, allergens, and mold.

4. FrostWash

FrostWash traps dust in ice on the heat exchanger, then flushes it through a drainage pipe, removing dust and other particles for a fresh, clean unit.

INDOOR AIR QUALITY FEATURES

FrostWash™ technology

Freeze

1

Frost is created from collected air moisture to cover the heat exchanger while it cools down to a maximum of 5° F.

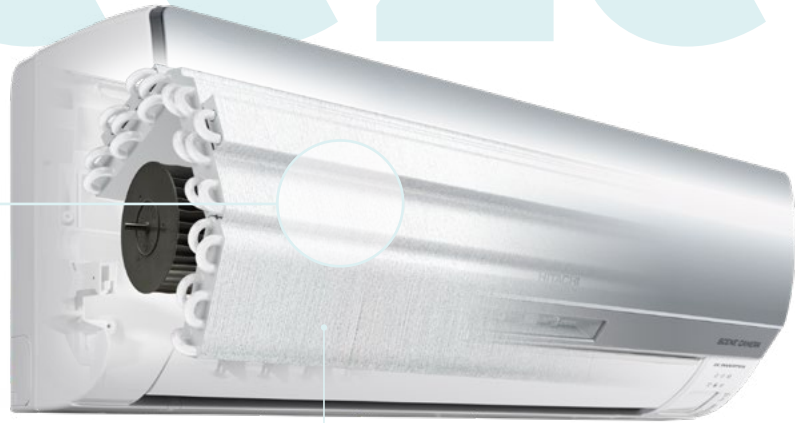

Air flows through the heat exchanger during standard operation. A clean heat exchanger keeps the air in your home fresher and cleaner.



Leave impurities out in the cold

All air conditioning units collect dust, bacteria, and other contaminants. When air blows over the heat exchanger, these impurities blow into the room, resulting in unhealthy air. But these contaminants have met their match in FrostWash. This innovative feature freezes dew that naturally accumulates on the heat exchanger, trapping impurities in place. It then melts the frost, washing the impurities safely down the drain. The result is a clean, hygienic surface.

& Melt

2

Dust, dirt, and other contaminants are frozen in place, then flushed away when frost is melted, reducing removing 99% of bacteria, 99% of virus and 95% of mold from unit interior*.



Unit shown for example purposes only.
Units available may differ by region.



No Sweat

The feature is as user-friendly as it is effective. An LED indicator light will turn on after 42 hours of operation, equivalent to 2-3 weeks of average run time. A touch of a button activates FrostWash. On units with Automatic Mode, the feature switches itself on automatically. (To ensure occupant comfort, it only activates when air conditioner isn't operating and there is no activity in room.) FrostWash offers yet another advantage. A cleaner unit is a more efficient unit. So, by maintaining a clean heat exchanger, FrostWash helps improve performance.

* Tested by Kitasato Research Center of Environmental Science. Test no. 2020_0650: anti-bacterial, anti-mold, and anti-virus effects when operating FrostWash 1 time.

COMFORT FEATURES

Dehumidification mode

Smart ideas for increased comfort



By selecting dehumidification mode, the unit will decrease room humidity¹ by gently cooling the room.

How it works:

- Dehumidifying function will only work if room temperature is over 60°F.
- When the room temperature is higher than the temperature setting, selecting dehumidification mode will reduce the room temperature to the preset level.
- When the room temperature is lower than the temperature setting, dehumidifying will be performed at the temperature setting lower than the current room temperature, regardless of the temperature setting.
- Eliminates up to 8 pints of moisture in the air per hour.



¹ Dehumidification level is different as per different models. For example, 24k BTU Standard model can remove up to 0.9 gallon /hour when properly sized.



Sleep in comfort

Air Sleep mode monitors activity in the room and adjusts cooling temperature accordingly for a good night's sleep.



How it works:

- With the Air Sleep sensor, activity level in the room is monitored. When sleep is confirmed, the temperature will increase by 1°F and the unit will continue running for 1 hour. Fan speed will be changed to SILENT.
- If the condition of activity in the room is stable, the unit will continue running with the temperature increased another 1°F. Temperature will decrease by 1°F when small activity is detected in the room.
- If increased human activity is detected, the temperature fan speed will be resumed back to previous setting.
- In Air Sleep mode, the brightness of the indoor unit indicator lamp will reduce.

¹ RESEARCH CONDUCTED BY Dr Kazuyo Tsuzuki (PhD), Principal Research Manager, Environmental Control Research Group, Human Technology Research Institute, National Institute of Advanced Industrial Science & Technology (AIST) in Japan 8.

CONTROL FEATURES

airCloud Home



Control the temperature for individual rooms, program schedules, and more with airCloud Home.

airCloud Home

This smartphone app puts control in the palm of your hand. The user-friendly interface makes it simple to set and change schedules for the greatest energy savings. And it's fully compatible with Amazon Alexa and Google Assistant, allowing the convenience of voice control.

Setup is quick, easy, and customizable; access can be shared with up to twenty people with individual permissions set as appropriate.

With this handy application, rooms are always the desired temperature — even if the thermostat wasn't set before leaving home. With anytime, anywhere control, the airCloud Home app ensures you'll always come home to comfort.

In control at home and away

A selection of intuitive controllers are available that provide precise control over system functions including temperature, schedules, louver position, and various modes — such as energy-saving or quiet mode. Enjoy both freedom and control with the new airCloud Home app.

Hey Google,

set temperature to 70 degrees.



airCloud Home

Set it and forget it

Set it and forget it With Smart-Fence*. You can connect your HVAC unit to your property and never worry about adjusting the temperature while you're away again, saving you money and ensuring you always come home to comfort.

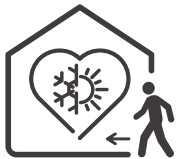
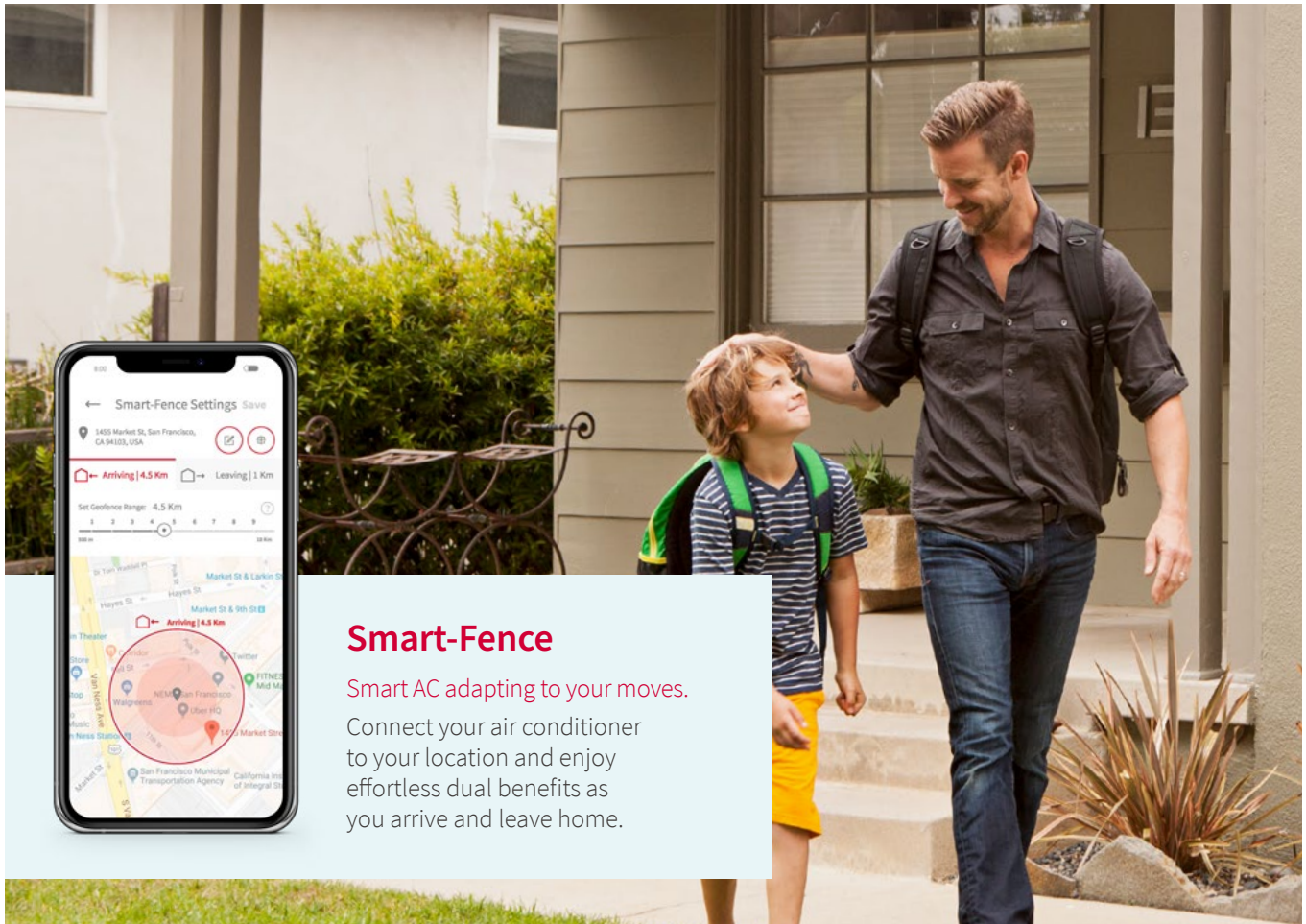

As you approach home

Your AC will automatically turn on, helping to create a comfortable and welcoming indoor climate.



As you leave home

Your AC will stop automatically or switch to a more economical preset temperature to save you energy.

Set a perimeter around your house and preferred settings for while you're out, and Smart-Fence will take it from there for work-free savings and comfort. Adjust the temperature or reset Smart-Fence any time from your airCloud Home app.

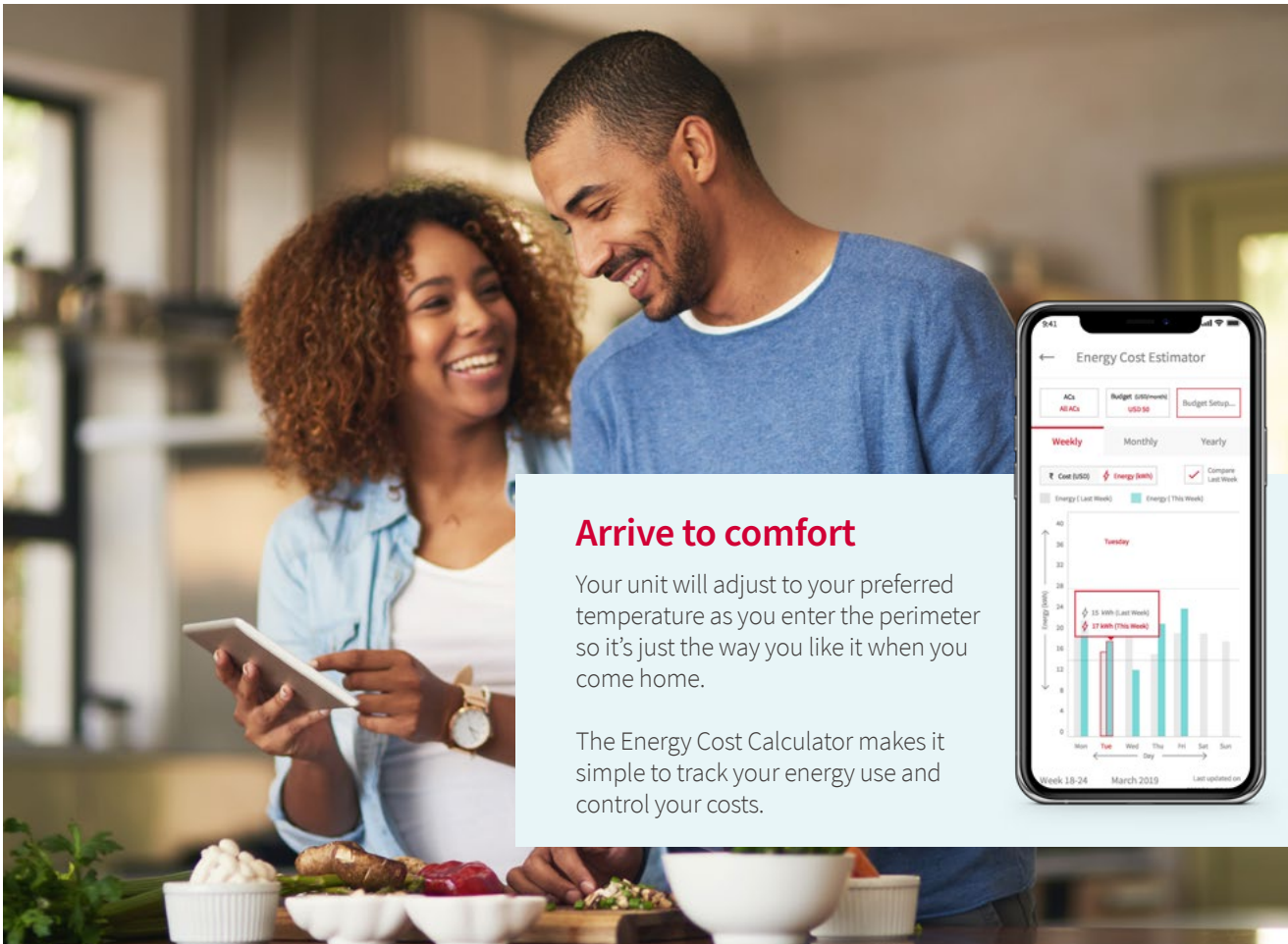

Arrive to comfort

Your unit will adjust to your preferred temperature as you enter the perimeter so it's just the way you like it when you come home.

The Energy Cost Calculator makes it simple to track your energy use and control your costs.

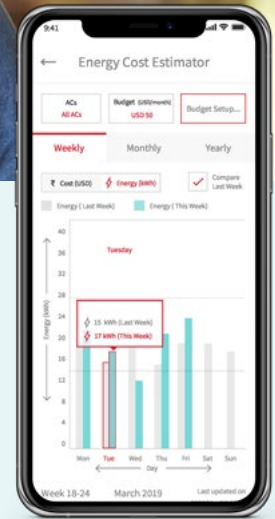

Take control of your energy spend

It's never been easier to manage your budget. airCloud Home's energy cost estimator provides all the information you need to monitor and control your energy costs.

Track energy use and preview estimates of your daily, weekly, monthly, or annual expenditure.

Use the intuitive scheduling features to help you meet your goals with schedules based on your daily routines.



Save while you're away

When you leave the perimeter, the unit will automatically stop or switch to an energy-saving preset temperature, reducing your energy bills.

Daily and weekly schedules make managing energy use easy.

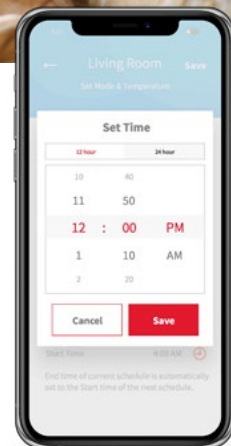

*airCloud Home requires a Wi-Fi adapter. Wi-Fi adapter comes standard on H500 and H700 series and is optional on all other models.

Right at home

Hitachi Mini-Splits solve multiple residential application challenges.

Room additions

A practical and economical solution compared to upgrading existing systems.

Apartments, condominiums, and townhouses

An ideal solution compared to the hassle, noise, obstructed view, and other issues associated with typical window units.







Older houses where ducts are not available

A smart, effective way to add air conditioning that does not require extensive construction or remodeling.



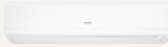

There's a system that's right for your application.





HITACHI MINI-SPLIT RESIDENTIAL PRODUCT LINE

Series	Efficiency Rating	Indoor Units	Rated Capacity (BTU/h) for Outdoor/Indoor Unit Combination						
			9K	12K	18K	24K	36K	42K	
H300 Single-Zone Heat Pump 	17-19 SEER	Wall-Mount Unit 	115V 208/230V	115V 208/230V	208/230V	208/230V	208/230V		
H500 Single-Zone Heat Pump 	20-22 SEER	Wall-Mount Unit 	208/230V	208/230V	208/230V	208/230V			
H700 Single-Zone Heat Pump 	20.5 SEER	Wall-Mount Unit 	208/230V	208/230V	208/230V	208/230V			
M400 Multi-Zone Heat Pump 	18-23 SEER	Multiple Indoor Unit Options 			208/230V	208/230V	208/230V	208/230V	

REMOTE CONTROLLERS

Model	RAR-MOB5	RAR-MOB6	RAR-MOB3	RAR-MOB4
Series	H300 Wall Units Standard	H500/H700 Wall Units Standard	M400 Cassette Units Standard	M400 Ducted Units Optional
				

ZONE CONTROLLERS

Model	SPX-RCDA1	SPX-WKT4	SPX-RCDB1	CCL01
Series	M400 Ducted Units Standard	All Optional	All except M400 Ducted Optional	All Optional
				

Feature descriptions

Indoor Air Quality

FrostWash

Eliminates dust build-up on the heat exchanger surface by trapping particles in ice, which are then flushed out via the drainage pipe.

Stainless Pre-Filter

Stainless Pre-filter enables easy cleaning compared to meshed filters.

Air Purifying Filter

Active carbon air purifying filters keep bacteria, allergens, and mold out of the air.

Washable Detachable Front Panel

The front panel of the unit can be easily removed for cleaning and maintenance.

Comfort

Dry Operation

Decreases room humidity by gently cooling the room.

Left-Right Auto Swing

Air flow direction is automatically directed left to right to deliver cool air evenly.

Powerful Mode

Engages maximum power and fan speed for rapid cooling or heating.

Seamless Fan Speed Control

Transitions smoothly between fan speed levels (Powerful, High, Medium, Low, Silent) for seamless performance.

Silent Mode

Activates quiet operation mode.

Timer (12h)

Timer setting that automatically turns off operation after a selected number of hours.

Up-Down Auto Swing

Air flow direction is automatically directed up and down to deliver cool air evenly.

Sensor System

Human absence/presence are monitored for ECO modes and Auto FrostWash.

Energy Saving

Air Sleep

By monitoring your sleep conditions during the night, temperature is optimized and automatically adjusted to silent operation for a restful sleep. Normal cooling mode reactivates when the sensor detects you are awake.

Eco Sleep Timer

When Eco Sleep Timer is set, the unit will shift to silent operation and optimum temperature for restful sleep. The operation will stop after the selected number of hours.

Eco Mode

Uses Sensor System to detect absence and presence of people and adjusts automatically for maximum comfort and minimum energy consumption.

Reliability

Anti-Corrosion Green Fin

Anti-corrosion green coating on the outdoor unit's heat exchanger increases durability.

Anti-Rust Outdoor Casing

Constructed of galvanized sheet with a baked synthetic resin coating designed to withstand rust and harsh weather conditions.

Auto Restart

Automatically restarts the air conditioning unit at the previous setting in the event of a power failure.

DC Power System

Uses DC indoor motors that are efficient, quiet and safe during maintenance.

Fireproof Electrical Casing

Electrical parts are securely located in a fireproof metal enclosure.

3-Minute Delay Circuit (Fuse Blow Prevention)

This safety feature protects fuses and internal components if operation is restarted accidentally.

Vector DC Inverter System

Uses a microchip pre-loaded with the compressor's mechanical data to monitor and adjust compressor rotation speed for efficient, powerful and stable operation.

Single-Zone Systems

H300 Single-Zone System

115V & 208/230V 9K-36K BTU/h
Inverter Heat Pump & Wall-Mount Units

- Manual FrostWash on indoor units
- System lock, cooling or heating only
- Optional Wi-Fi capability
- Vector DC inverter
- Energy Star Certified (115V)



Standard
Wireless Remote Controller
Model RAR-MOB5



Optional
Wired Controller
SPX-RCDB1



Optional
Model SPX-WKT4



Optional
airCloud Home App
(adapter RA-SPX-WFA required)

H300 SINGLE-ZONE SYSTEM

Model	Indoor		RAS-EH09PHLAB*	RAS-EH12PHLAB*	RAS-EH09RHAE	RAS-EH12RHAE	RAS-EH18RHAE	RAS-EH24RHAE	RAS-EH36PHAE
	Outdoor		RAC-EH09WHLAB*	RAC-EH12WHLAB*	RAC-EH09WHLAE	RAC-EH12WHLAE	RAC-EH18WHLAE	RAC-EH24WHLAE	RAC-EH36WHLAE
	System Type		Heat Pump	Heat Pump	Heat Pump	Heat Pump	Heat Pump	Heat Pump	Heat Pump
Performance	Rated Cooling Capacity (Min-Max)	BTU / h	9000 (5450 - 10500)	12000 (5500 - 13200)	9000 (5450 - 10500)	12000 (5500 - 13200)	17600 (5700 - 18600)	24000 (8200 - 25200)	33000 (7000 - 34000)
	Rated Heating Capacity (Min-Max)	BTU / h	10500 (4200 - 11500)	13000 (4400 - 14500)	10500 (4200 - 11500)	13000 (4400 - 14500)	19000 (6600 - 20500)	25000 (8300 - 26500)	36000 (9000 - 37500)
	EER		12.5	9.8	12.5	9.8	9	9	8.3
	SEER		19	17.5	19	17.5	17	18	17.5
	HSPF		11	10.5	11	10.5	10	10	9
	Heating Capacity at +17 F (-8 C)	BTU / h	8400	10400	8400	10400	15000	17800	24500
	Heating Capacity at +5 F (-15 C)	BTU / h	6800	8500	6800	8500	12350	15000	19800
Moisture Removal	l / h	1.4	1.6	1.4	1.6	2.9	3.4	4.9	
Electrical	Power Supply	V / Ph / Hz	115 / 1 / 60	115 / 1 / 60	208/230 / 1 / 60	208/230 / 1 / 60	208/230 / 1 / 60	208/230 / 1 / 60	208/230 / 1 / 60
	MCA	Amps	18	18	10	10	16	18	27
	MOP	Amps	20	20	15	15	20	20	40
Indoor Unit	Airflow (H / M / L / SL)	CFM	290 / 250 / 218 / 170	320 / 250 / 218 / 170	290 / 250 / 218 / 170	320 / 250 / 218 / 170	400 / 280 / 240 / 200	620 / 430 / 350 / 280	640 / 530 / 430 / 350
	Sound Pressure Level (H / M / S / SL)	dB(A)	42 / 40 / 36 / 29	44 / 40 / 36 / 29	42 / 40 / 36 / 29	44 / 40 / 36 / 29	48 / 42 / 38 / 35	51 / 45 / 40 / 35	53 / 48 / 45 / 39
	Unit Dimension (WxHxD)	inch (mm)	30.7x11.1x9.1 (780x280x230)	30.7x11.1x9.1 (780x280x230)	30.7x11.1x9.1 (780x280x230)	30.7x11.1x9.1 (780x280x230)	30.7x11.1x9.1 (780x280x230)	43.3x11.8x10.2 (1100x300x260)	43.3x11.8x10.2 (1100x300x260)
	Net / Gross Weight	lbs (kg)	17.6 / 19.8 (8 / 9)	17.6 / 19.8 (8 / 9)	17.6 / 19.8 (8 / 9)	17.6 / 19.8 (8 / 9)	33.1 / 37.5 (15 / 17)	33.1 / 37.5 (15 / 17)	33.1 / 37.5 (15 / 17)
Outdoor Unit	Operation Range - Cooling	F (C)	0 - 115 (-18 - 46)	0 - 115 (-18 - 46)	0 - 115 (-18 - 46)	0 - 115 (-18 - 46)	0 - 115 (-18 - 46)	0 - 115 (-18 - 46)	0 - 115 (-18 - 46)
	Operation Range - Heating	F (C)	0 - 75 (-18 - 24)	0 - 75 (-18 - 24)	0 - 75 (-18 - 24)	0 - 75 (-18 - 24)	0 - 75 (-18 - 24)	0 - 75 (-18 - 24)	0 - 75 (-18 - 24)
	Sound Pressure Level (High)	dB(A)	51	51	51	51	53	53	58
	Unit Dimension (WxHxD)	inch (mm)	26x20.8x11 (660x530x278)	26x20.8x11 (660x530x278)	26x20.8x11 (660x530x278)	26x20.8x11 (660x530x278)	33.5x25.6x11.7 (850x650x298)	37.4x37.2x14.6 (950x945x370)	33.5x25.6x11.7 (850x650x298)
	Net / Gross Weight	lbs (kg)	57.3 / 61.7 (26 / 28)	57.3 / 61.7 (26 / 28)	57.3 / 61.7 (26 / 28)	57.3 / 61.7 (26 / 28)	94.8 / 102.5 (43 / 46.5)	97 / 103.6 (44 / 47)	189.5 / 209.9 (86 / 95.2)
Piping	Max Total Piping Length	Ft (m)	82 (25)	82 (25)	82 (25)	82 (25)	82 (25)	82 (25)	98.5 (30)
	Max Total Piping Height	Ft (m)	49.2 (15)	49.2 (15)	49.2 (15)	49.2 (15)	49.2 (15)	49.2 (15)	65.6 (20)
	Refrigerant				R410A				
Piping Connections	Liquid	in (mm)	1/4 (6.35)	1/4 (6.35)	1/4 (6.35)	1/4 (6.35)	1/4 (6.35)	1/4 (6.35)	1/4 (6.35)
	Gas	in (mm)	3/8 (9.53)	3/8 (9.53)	3/8 (9.53)	3/8 (9.53)	1/2 (12.7)	5/8 (15.87)	5/8 (15.87)
	Drain	in (mm)	5/8 (15.87)	5/8 (15.87)	5/8 (15.87)	5/8 (15.87)	5/8 (15.87)	5/8 (15.87)	5/8 (15.87)
Features	FrostWash		Indoor Only	Indoor Only	Indoor Only	Indoor Only	Indoor Only	Indoor Only	Indoor Only
	Wi-Fi Capability		Optional	Optional	Optional	Optional	Optional	Optional	Optional
Options	System lock, cooling or heating only		Switchable	Switchable	Switchable	Switchable	Switchable	Switchable	Switchable

MINI-SPLIT SYSTEMS

H300 SINGLE-ZONE SYSTEM

*115V models are Energy Star Certified.

Please refer to Product submittals for gas/liquid lines port sizes.

Test conditions are based on AHRI 210/240. *1. Rating conditions (cooling) – Indoor: D.B. 80° F (27° C), W.B. 67° F (19° C); Outdoor: D.B. 95° F (35° C), W.B. 75° F (24° C).

Rating conditions (heating) – Indoor* D.B. 70° F (21° C), W.B. 60° F (16° C); Outdoor: D.B. 47° F (8° C), W.B. 43° F (6° C). Specifications are subject to change without notice. Manufacturer reserves the right to discontinue or change at any time, specifications or designs without notice or without incurring obligations.



Single-Zone Systems

H500 Single-Zone System

208/230V 9K-24K BTU/h Inverter Heat Pump & Wall-Mount Units

- FrostWash indoor and outdoor units
- Standard Wi-Fi capability
- Human Sensor System
- Air Sleep function
- Vector DC inverter
- Energy Star certified
- Remote control temperature sensor



Standard
Wireless Remote Controller
Model RAR-MOB6



Optional
Wired Controller
Model SPX-RCDB1



Optional
Wired Controller
Model SPX-WKT4



Standard
airCloud Home App



H500 SINGLE-ZONE SYSTEM

MINI-SPLIT SYSTEMS

H500 SINGLE-ZONE SYSTEM

Model	Indoor		RAS-SH09RHLAE	RAS-SH12RHLAE	RAS-SH18RHLAE	RAS-SH24RHLAE
	Outdoor		RAC-SH09WHLAE	RAC-SH12WHLAE	RAC-SH18WHLAE	RAC-SH24WHLAE
	System Type		Heat Pump	Heat Pump	Heat Pump	Heat Pump
Performance	Rated Cooling Capacity (Min-Max)	BTU / h	9000 (5100 - 10500)	12000 (5150 - 14000)	18000 (6600 - 20500)	22000 (9700 - 25000)
	Rated Heating Capacity (Min-Max)	BTU / h	11000 (5450 - 15000)	14000 (5500 - 18000)	21500 (7100 - 26000)	25000 (8500 - 29500)
	EER		14	12.5	12.5	12.5
	SEER		20	20	22	20
	HSPF		11.5	11	11	11
	Heating Capacity at +17 F (-8 C)	BTU / h	9650	12300	18300	21250
	Heating Capacity at +5 F (-15 C)	BTU / h	8050	10000	15400	18250
	Heating Capacity at -4 F (-20 C)	BTU / h	7000	8600	13200	15500
	Moisture Removal	l / h	1	1.5	1.8	2.5
Electrical	Power Supply	V / Ph / Hz	(208/230) / 1 / 60	(208/230) / 1 / 60	208/230 / 1 / 60	208/230 / 1 / 60
	MCA	Amps	12	12	17	20
	MOP	Amps	15	15	20	20
Indoor Unit	Airflow (H / M / L / SL)	CFM	320 / 280 / 200 / 150	400 / 280 / 200 / 150	540 / 410 / 320 / 260	650 / 500 / 405 / 299
	Sound Pressure Level (H / M / S / SL)	dB(A)	43 / 40 / 35 / 27	46 / 40 / 35 / 27	49 / 45 / 42 / 35	52 / 47 / 43 / 36
	Unit Dimension (WxHxD)	inch (mm)	35.43x11.81x9.05 (900x300x230)	35.43x11.81x9.05 (900x300x230)	43.3x11.81x10.23 (1100x300x260)	43.3x11.81x10.23 (1100x300x260)
	Net / Gross Weight	lbs (kg)	25.4 / 28.6 (11.5 / 13)	25.4 / 28.6 (11.5 / 13)	33.1 / 37.5 (15 / 17)	33.1 / 37.5 (15 / 17)
Outdoor Unit	Operation Range - Cooling	F (C)	0 - 115 (-18 - 46)	0 - 115 (-18 - 46)	0 - 115 (-18 - 46)	0 - 115 (-18 - 46)
	Operation Range - Heating	F (C)	-13 - 75 (-25 - 24)	-13 - 75 (-25 - 24)	-13 - 75 (-25 - 24)	-13 - 75 (-25 - 24)
	Sound Pressure Level (High)	dB(A)	52	52	53	53
	Unit Dimension (WxHxD)	inch (mm)	29.52x22.44x11.02 (750x570x280)	29.52x22.44x11.02 (750x570x280)	33.46x31.49x11.73 (850x800x298)	33.46x31.49x11.73 (850x800x298)
	Net / Gross Weight	lbs (kg)	58 / 60.2 (26.3 / 27.3)	58 / 60.2 (26.3 / 27.3)	119.2 / 130.3 (54.1 / 59.1)	120 / 131 (54.4 / 59.4)
Piping	Max Total Piping Length	Ft (m)	82 (25)	82 (25)	82 (25)	82 (25)
	Max Total Piping Height	Ft (m)	49.2 (15)	49.2 (15)	49.2 (15)	49.2 (15)
	Refrigerant		R410A			
Piping Connections	Liquid	in (mm)	1/4 (6.35)	1/4 (6.35)	1/4 (6.35)	1/4 (6.35)
	Gas	in (mm)	3/8 (9.53)	3/8 (9.53)	1/2 (12.7)	5/8 (15.87)
	Drain	in (mm)	5/8 (15.87)	5/8 (15.87)	5/8 (15.87)	5/8 (15.87)
Options	FrostWash		Indoor & Outdoor	Indoor & Outdoor	Indoor & Outdoor	Indoor & Outdoor
	Wifi Capability		Standard	Standard	Standard	Standard

Please refer to Product submittals for gas/liquid lines port sizes.
 Test conditions are based on AHRI 210/240. *1. Rating conditions (cooling) – Indoor: D.B. 80° F (27° C), W.B. 67° F (19° C); Outdoor: D.B. 95° F (35° C), W.B. 75° F (24° C).
 Rating conditions (heating) – Indoor* D.B. 70° F (21° C), W.B. 60° F (16° C); Outdoor: D.B. 47° F (8° C), W.B. 43° F (6° C).
 Specifications are subject to change without notice. Manufacturer reserves the right to discontinue or change at any time, specifications or designs without notice or without incurring obligations.

Single-Zone Systems

H700 Single-Zone System

208/230V 9K-24K BTU/h Inverter Heat Pump & Wall-Mount Units

- Constant Heating Capacity (CHC) down to -13° F
- 100% heating capacity at +5° F
- FrostWash indoor and outdoor units
- Standard Wi-Fi capability
- Human Sensor System
- Air Sleep function
- Vector DC inverter
- Energy Star certified
- Remote control temperature sensor



Standard
Wireless Remote Controller
Model RAR-MOB6



Optional
Wired Controller
Model SPX-RCDB1



Optional
Wired Controller
Model SPX-WKT4



Standard
airCloud Home App



H700 SINGLE-ZONE SYSTEM

MINI-SPLIT SYSTEMS

Model	Indoor		RAS-PH09RHLAE	RAS-PH12RHLAE	RAS-PH18RHLAE	RAS-PH24RHLAE
	Outdoor		RAC-PH09WHLAE	RAC-PH12WHLAE	RAC-PH18WHLAE	RAC-PH24WHLAE
	System Type		Heat Pump	Heat Pump	Heat Pump	Heat Pump
Performance	Rated Cooling Capacity (Min-Max)	BTU / h	9000 (2400 - 12000)	12000 (2400 - 14000)	18000 (6800 - 22000)	22000 (7200 - 27000)
	Rated Heating Capacity (Min-Max)	BTU / h	12000 (4700 - 22000)	14500 (4700 - 19000)	21600 (8800 - 28000)	25000 (9200 - 31000)
	EER		13.2	13.0	13.5	13.2
	SEER		20.5	20.5	20.5	20.5
	HSPF		12.5	12.2	12.5	12.2
	Heating Capacity at +17 F (-8 C)	BTU / h	14600	17600	25000	25800
	Heating Capacity at +5 F (-15 C)	BTU / h	12000	14500	21600	23100*
	Heating Capacity at -4 F (-20 C)	BTU / h	11500	12000	18200	18600
	Moisture Removal	l / h	0.6	1.2	2.1	2.5
Electrical	Power Supply	V / Ph / Hz	(208/230) / 1 / 60	(208/230) / 1 / 60	(208/230) / 1 / 60	(208/230) / 1 / 60
	MCA	Amps	12	12	20	20
	MOP	Amps	15	15	20	20
Indoor Unit	Airflow (H / M / L / SL)	CFM	320 / 280 / 200 / 150	400 / 280 / 200 / 150	540 / 410 / 320 / 260	650 / 500 / 405 / 299
	Sound Pressure Level (H / M / S / SL)	dB(A)	43 / 40 / 35 / 27	46 / 40 / 35 / 27	49 / 45 / 42 / 35	52 / 47 / 43 / 36
	Unit Dimension (WxHxD)	inch (mm)	35.43x11.81x9.05 (900x300x230)	35.43x11.81x9.05 (900x300x230)	43.3x11.81x10.23 (1100x300x260)	43.3x11.81x10.23 (1100x300x260)
	Net / Gross Weight	lbs (kg)	25.4 / 28.6 (11.5 / 13)	25.4 / 28.6 (11.5 / 13)	33.1 / 37.5 (15 / 17)	33.1 / 37.5 (15 / 17)
Outdoor Unit	Operation Range - Cooling	F (C)	0 - 115 (-18 - 46)	0 - 115 (-18 - 46)	0 - 115 (-18 - 46)	0 - 115 (-18 - 46)
	Operation Range - Heating	F (C)	-13 - 75 (-25 - 24)	-13 - 75 (-25 - 24)	-13 - 75 (-25 - 24)	-13 - 75 (-25 - 24)
	Sound Pressure Level (High)	dB(A)	52	52	55	55
	Unit Dimension (WxHxD)	inch (mm)	33.46x25.59x11.73 (850x650x298)	33.46x25.59x11.73 (850x650x298)	37.40x37.20x14.57 (950x945x370)	37.40x37.20x14.57 (950x945x370)
	Net / Gross Weight	lbs (kg)	93.70 / 101.4 (42.5/46)	93.70 / 101.4 (42.5/46)	174.2 / 200.62 (79.0/91.0)	175.3 / 201.7 (79.5/91.5)
Piping	Max Total Piping Length	Ft (m)	82 (25)	82 (25)	98.5 (30)	98.5 (30)
	Max Total Piping Height	Ft (m)	49.2 (15)	49.2 (15)	65.6 (20)	65.6 (20)
	Refrigerant		R410A			
Piping Connections	Liquid	in (mm)	1/4 (6.35)	1/4 (6.35)	1/4 (6.35)	1/4 (6.35)
	Gas	in (mm)	3/8 (9.53)	3/8 (9.53)	1/2 (12.7)	5/8 (15.87)
	Drain	in (mm)	5/8 (15.87)	5/8 (15.87)	5/8 (15.87)	5/8 (15.87)
Options	FrostWash		Indoor & Outdoor	Indoor & Outdoor	Indoor & Outdoor	Indoor & Outdoor
	Wifi Capability		Standard	Standard	Standard	Standard

H700 SINGLE-ZONE SYSTEM

*100% capacity at 5° F is applicable for all sizes except 24K.
 Please refer to Product submittals for gas/liquid lines port sizes.
 Test conditions are based on AHRI 210/240. *1. Rating conditions (cooling) – Indoor: D.B. 80° F (27° C), W.B. 67° F (19° C); Outdoor: D.B. 95° F (35° C), W.B. 75° F (24° C).
 Rating conditions (heating) – Indoor* D.B. 70° F (21° C), W.B. 60° F (16° C); Outdoor: D.B. 47° F (8° C), W.B. 43° F (6° C).
 Specifications are subject to change without notice. Manufacturer reserves the right to discontinue or change at any time, specifications or designs without notice or without incurring obligations.

Multi-Zone Systems



M400 Multi-Zone System

208/230 18K-42K BTU/h
Inverter Heat Pump

- Multiple indoor unit options
- Up to 5 zones
- Optional Wi-Fi capability (standard for H500 indoor unit)
- Human sensor system (with H500 indoor unit)
- Vector DC inverter
- Energy Star certified

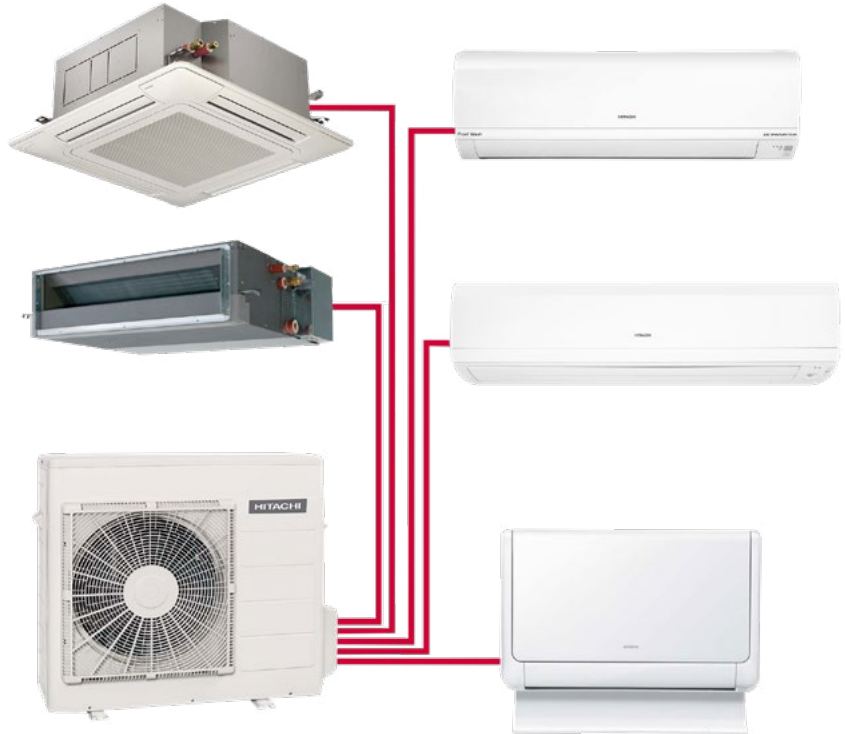

MODEL RAR-MOB6
Comes standard with H500 Series



Standard
Wireless Remote Controller
Model RAR-MOB3



Standard with Ducted Units
Wired Controller
SPX-RCDA1



Optional
Wireless Remote Controller
Model RAR-MOB4



Optional
Wired Controller
Model SPX-WKT4



Optional
Wired Controller
SPX-RCDB1



Optional
airCloud Home App
(Adapter SPX-WFA required except for H500 indoor unit)



M400 MULTI-ZONE SYSTEM OUTDOOR UNITS

MINI-SPLIT SYSTEMS

Model	Outdoor Unit		RAM-S18U2HLAE		RAM-S24U3HLAE		RAM-S36U4HLAE		RAM-S42U5HLAE	
	Indoor Unit		Non-Ducted	Ducted	Non-Ducted	Ducted	Non-Ducted	Ducted	Non-Ducted	Ducted
System Type		Heat Pump		Heat Pump		Heat Pump		Heat Pump		
Number Indoor Connection		2		3		4		5		
Performance	Rated Cooling Capacity (Min-Max)	BTU / h	18000 (7000 - 21000)		24000 (7000 - 28800)		36000 (7000 - 40000)		42000 (7000 - 46000)	
	Rated Heating Capacity (Min-Max)	BTU / h	22000 (9000 - 24500)		28000 (9000 - 32000)		40000 (9000 - 42000)		48000 (9000 - 51000)	
	SEER		22.0	19.0	20.0	18.0	20.0	18.0	23.0	18.5
	EER		12.5	12.0	12.5	10.0	12.5	9.0	12.5	9.0
	HSPF		10.3	10.3	10.5	10.2	10.5	9.5	10.8	10.5
Electrical	Power Supply	V / Ph / Hz	(208 / 230) / 1 / 60		208/230 / 1 / 60		208/230 / 1 / 60		208/230 / 1 / 60	
	MCA	Amps	17		21		24		29	
	MOP	Amps	25		35		40		50	
Outdoor Unit	Operation Range - Cooling	F (C)	14 - 115 (-10 - 46)		14 - 115 (-10 - 46)		14 - 115 (-10 - 46)		14 - 115 (-10 - 46)	
	Operation Range - Heating	F (C)	-4 - 75 (-20 - 24)		-4 - 75 (-20 - 24)		-4 - 75 (-20 - 24)		-4 - 75 (-20 - 24)	
	Unit Dimension (WxHxD)	in (mm)	29.5x33.5x11.7 (750x850x298)		33.5x31.5x11.75 (850x800x298)		37.4x31.5x14.6 (950x800x370)		40.75x37.2x14.6 (1035x945x370)	
	Net / Gross Weight	lb (kg)	112.4 / 114.6 (51 / 52.1)		121.2 / 126.3 (55 / 57.4)		176.4 / 183 (80 / 83.2)		220.5 / 241.1 (100 / 109.6)	
	Refrigerant		R410A							
Piping	Pre-Charge Length	Ft (m)	98.5 (30)		98.5 (30)		98.5 (30)		98.5 (30)	
	Max Total Piping Length	Ft (m)	164 (50)		197 (60)		197 (60)		246 (75)	
	Max Total Piping Height	Ft (m)	66 (20)		66 (20)		66 (20)		66 (20)	
	Max. Height Diff.	Ft (m)	16.5 (5)		16.5 (5)		16.5 (5)		16.5 (5)	
	Max Equivalent Length (Piping to furthest indoor unit)	Ft (m)	82 (25)		82 (25)		82 (25)		82 (25)	
	Port 1 Piping Connection Diameter - Liquid	in (mm)	1/4 (6.35)		1/4 (6.35)		1/4 (6.35)		1/4 (6.35)	
	Port 1 Piping Connection Diameter - Gas	in (mm)	3/8 (9.53)		3/8 (9.53)		3/8 (9.53)		3/8 (9.53)	
	Port 2 Piping Connection Diameter - Liquid	in (mm)	1/4 (6.35)		1/4 (6.35)		1/4 (6.35)		1/4 (6.35)	
	Port 2 Piping Connection Diameter - Gas	in (mm)	3/8 (9.525)		3/8 (9.525)		3/8 (9.525)		3/8 (9.525)	
	Port 3 Piping Connection Diameter - Liquid	in (mm)			1/4 (6.35)		1/4 (6.35)		1/4 (6.35)	
	Port 3 Piping Connection Diameter - Gas	in (mm)			3/8 (9.525)		3/8 (9.525)		3/8 (9.525)	
	Port 4 Piping Connection Diameter - Liquid	in (mm)					1/4 (6.35)		1/4 (6.35)	
	Port 4 Piping Connection Diameter - Gas	in (mm)					1/2 (12.7)		1/2 (12.7)	
	Port 5 Piping Connection Diameter - Liquid	in (mm)							1/4 (6.35)	
Port 5 Piping Connection Diameter - Gas	in (mm)							1/2 (12.7)		
Option	Wifi Capability	Optional except Standard H500 Wall Mount Indoor Unit								

M400 MULTI-ZONE SYSTEM

Please refer to Product submittals for gas/liquid lines port sizes. Test conditions are based on AHRI 210/240. *1. Rating conditions (cooling) – Indoor: D.B. 80° F (27° C), W.B. 67° F (19° C); Outdoor: D.B. 95° F (35° C), W.B. 75° F (24° C). Rating conditions (heating) – Indoor: D.B. 70° F (21° C), W.B. 60° F (16° C); Outdoor: D.B. 47° F (8° C), W.B. 43° F (6° C). Specifications are subject to change without notice. Manufacturer reserves the right to discontinue or change at any time, specifications or designs without notice or without incurring obligations.

M400 MULTI-ZONE SYSTEM INDOOR UNITS

H300 Wall Mount Unit

- Optional Wi-Fi capability
- Eco Mode Fixed



Model	Wall Mount Indoor		RAS-EH07QHAE	RAS-EH09RHLAE	RAS-EH12RHAE	RAS-EH18RHLAE	RAS-EH24RHLAE
	System Type		Heat Pump	Heat Pump	Heat Pump	Heat Pump	Heat Pump
Performance	Rated Cooling Capacity (Min-Max)	BTU / h	7000 (3050 - 9000)	9000 (4300 - 10500)	12000 (4450 - 13200)	17600 (5600 - 18600)	24000 (8200 - 25200)
	Rated Heating Capacity (Min-Max)	BTU / h	9000 (3050 - 10900)	10500 (4200 - 11500)	13000 (4400 - 14500)	19000 (6600 - 20500)	25000 (9950 - 26500)
Power Supply	Rated Voltage	V / Ph / Hz	208/230 / 1 / 60	208/230 / 1 / 60	208/230 / 1 / 60	208/230 / 1 / 60	208/230 / 1 / 60
Indoor Unit	Airflow (H / M / L / SL)	CFM	290 / 250 / 218 / 170	290 / 250 / 218 / 170	320 / 250 / 218 / 170	400 / 280 / 240 / 200	400 / 280 / 240 / 200
	Sound Pressure Level (H / M / S / SL)	dB(A)	42 / 40 / 36 / 29	44 / 40 / 36 / 29	44 / 40 / 36 / 29	48 / 42 / 38 / 35	51 / 45 / 40 / 35
	Unit Dimension (WxHxD)	in (mm)	30.7x11.1x9.1 (780x280x230)	30.7x11.1x9.1 (780x280x230)	30.7x11.1x9.1 (780x280x230)	30.7x11.1x9.1 (780x280x230)	43.3x11.8x10.2 (1100x300x260)
	Net / Gross Weight	lbs (kg)	17.6 / 19.8 (8 / 9)	17.6 / 19.8 (8 / 9)	17.6 / 19.8 (8 / 9)	33.1 / 37.5 (15 / 17)	33.1 / 37.5 (15 / 17)
Piping Connections	Liquid	in (mm)	1/4 (6.35)	1/4 (6.35)	1/4 (6.35)	1/4 (6.35)	1/4 (6.35)
	Gas	in (mm)	3/8 (9.53)	1/2 (12.7)	5/8 (15.87)	1/2 (12.7)	5/8 (15.87)
	Drain	in (mm)	5/8 (15.87)	5/8 (15.87)	5/8 (15.87)	5/8 (15.87)	5/8 (15.87)
Option	Wi-Fi (Adapter Required)		Optional	Optional	Optional	Optional	Optional

Please refer to Product submittals for gas/liquid lines port sizes.

Test conditions are based on AHRI 210/240. *1. Rating conditions (cooling) – Indoor: D.B. 80° F (27° C), W.B. 67° F (19° C); Outdoor: D.B. 95° F (35° C), W.B. 75° F (24° C).

Rating conditions (heating) – Indoor* D.B. 70° F (21° C), W.B. 60° F (16° C); Outdoor: D.B. 47° F (8° C), W.B. 43° F (6° C).

Specifications are subject to change without notice. Manufacturer reserves the right to discontinue or change at any time, specifications or designs without notice or without incurring obligations.

M400 MULTI-ZONE SYSTEM INDOOR UNITS

H500 Wall Mount Unit

- Standard Wi-Fi capability
- Eco Mode by Human Sensor



MINI-SPLIT SYSTEMS

Model	Wall Mount Indoor System Type		RAS-SH07QHAE	RAS-SH09RHAE	RAS-SH12RHAE	RAS-SH18RHAE	RAS-SH24RHAE
			Heat Pump	Heat Pump	Heat Pump	Heat Pump	Heat Pump
Performance	Rated Cooling Capacity (Min-Max)	BTU / h	7000 (3050 - 9000)	9000 (4300 - 10500)	12000 (4450 - 14000)	18000 (5600 - 20500)	22000 (8200 - 25000)
	Rated Heating Capacity (Min-Max)	BTU / h	9000 (3050 - 10900)	11000 (4200 - 15000)	14000 (4400 - 18000)	21500 (6600 - 26000)	25000 (9950 - 29500)
Power Supply	Rated Voltage	V / Ph / Hz	208/230 / 1 / 60	208/230 / 1 / 60	208/230 / 1 / 60	208/230 / 1 / 60	208/230 / 1 / 60
Indoor Unit	Airflow (H / M / L / SL)	CFM	320 / 280 / 200 / 150	320 / 280 / 200 / 150	400 / 280 / 200 / 150	540 / 410 / 320 / 260	650 / 500 / 405 / 299
	Sound Pressure Level (H / M / S / SL)	dB(A)	43 / 40 / 35 / 27	43 / 40 / 35 / 27	46 / 40 / 35 / 27	49 / 45 / 42 / 35	52 / 47 / 43 / 36
	Unit Dimension (WxHxD)	in (mm)	35.43x11.81x9.05 (900x300x230)	35.43x11.81x9.05 (900x300x230)	35.43x11.81x9.05 (900x300x230)	43.3x11.81x10.23 (1100x300x260)	43.3x11.81x10.23 (1100x300x260)
	Net / Gross Weight	lbs (kg)	33.1 / 37.5 (15 / 17)	25.4 / 28.6 (11.5 / 13)	25.4 / 28.6 (11.5 / 13)	33.1 / 37.5 (15 / 17)	33.1 / 37.5 (15 / 17)
Piping Connections	Liquid	in (mm)	1/4 (6.35)	1/4 (6.35)	1/4 (6.35)	1/4 (6.35)	1/4 (6.35)
	Gas	in (mm)	3/8 (9.53)	3/8 (9.53)	3/8 (9.53)	1/2 (12.7)	5/8 (15.87)
	Drain	in (mm)	5/8 (15.87)	5/8 (15.87)	5/8 (15.87)	5/8 (15.87)	5/8 (15.87)
Option	Wi-Fi		Standard	Standard	Standard	Standard	Standard

M400 MULTI-ZONE SYSTEM

Please refer to Product submittals for gas/liquid lines port sizes.

Test conditions are based on AHRI 210/240. *1. Rating conditions (cooling) – Indoor: D.B. 80° F (27° C), W.B. 67° F (19° C); Outdoor: D.B. 95° F (35° C), W.B. 75° F (24° C).

Rating conditions (heating) – Indoor* D.B. 70° F (21° C), W.B. 60° F (16° C); Outdoor: D.B. 47° F (8° C), W.B. 43° F (6° C).

Specifications are subject to change without notice. Manufacturer reserves the right to discontinue or change at any time, specifications or designs without notice or without incurring obligations.

M400 MULTI-ZONE SYSTEM INDOOR UNITS

M400 Cassette Indoor Unit

- Optional Wi-Fi capability
- Eco Mode Fixed
- 4-way air discharge
- Internal condensate drain pump



Model	Cassette Indoor		RAI-SH07QHLAE	RAI-SH09QHLAE	RAI-SH12QHLAE	RAI-SH18QHLAE
	System Type		Heat Pump	Heat Pump	Heat Pump	Heat Pump
Performance	Nominal Capacity	BTU / h	7000 (3050 - 8500)	9000 (3050 - 10200)	12000 (3050 - 13650)	18000 (4100 - 19800)
Power Supply	Rated Voltage	V / Ph / Hz	208/230/ 1 / 60	208/230/ 1 / 60	208/230/ 1 / 60	208/230/ 1 / 60
Specifications	Airflow (H / M / L / SL)	CFM	388 / 347 / 297 / 212	388 / 347 / 297 / 212	388 / 347 / 297 / 212	424 / 371 / 318 / 230
	Cooling Sound Pressure Level (H / M / S / SL)	dB(A)	38/35/31/27	38/35/31/27	40/37/33/27	43/39/35/29
	Heating Sound Pressure Level (H / M / S / SL)	dB(A)	39/36/32/28	39/36/32/28	41/38/34/28	44/40/36/30
	Unit Dimension (WxHxD)	in (mm)	11x22x22 (285x570x570)	11x22x22 (285x570x570)	11x22x22 (285x570x570)	11x22x22 (285x570x570)
	Net / Gross Weight	lbs (kg)	37 / 46 (17 / 21)	37 / 46 (17 / 21)	37 / 46 (17 / 21)	37 / 46 (17 / 21)
	Air Direction Control		Vertical/-	Vertical/-	Vertical/-	Vertical/-
Piping Connections	Liquid	in (mm)	1/4 (6.35)	1/4 (6.35)	1/4 (6.35)	1/4 (6.35)
	Gas	in (mm)	3/8 (9.53)	3/8 (9.53)	3/8 (9.53)	1/2 (12.7)
	Drain	in (mm)	1.26 (32)*	1.26 (32)*	1.26 (32)*	1.26 (32)*
Option	Wi-Fi (Adapter Required)		Optional	Optional	Optional	Optional

(*) Outer diameter (VP25)

Please refer to Product submittals for gas/liquid lines port sizes.

Test conditions are based on AHRI 210/240. *1. Rating conditions (cooling) – Indoor: D.B. 80° F (27° C), W.B. 67° F (19° C); Outdoor: D.B. 95° F (35° C), W.B. 75° F (24° C).

Rating conditions (heating) – Indoor* D.B. 70° F (21° C), W.B. 60° F (16° C); Outdoor: D.B. 47° F (8° C), W.B. 43° F (6° C).

Specifications are subject to change without notice. Manufacturer reserves the right to discontinue or change at any time, specifications or designs without notice or without incurring obligations.

M400 MULTI-ZONE SYSTEM INDOOR UNITS

M400 Floor Indoor Unit

- Optional Wi-Fi capability
- Compact, slim design
- Eco Mode Fixed



MINI-SPLIT SYSTEMS

Model	Floor Indoor		RAF-SH07QHAE	RAF-SH09QHAE	RAF-SH12QHAE	RAF-SH18QHAE
	System Type		Heat Pump	Heat Pump	Heat Pump	Heat Pump
Performance	Nominal Capacity	BTU / h	7000 (3050 - 9000)	9000 (3050 - 10600)	12000 (3050 - 13650)	18000 (3050 - 19750)
Power Supply	Rated Voltage	V / Ph / Hz	208/230/ 1 / 60	208/230/ 1 / 60	208/230/ 1 / 60	208/230/ 1 / 60
Specifications	Airflow (H / M / L / SL)	CFM	339 / 321 / 247 / 176	339 / 321 / 247 / 176	378 / 360 / 307 / 208	434 / 360 / 346 / 233
	Sound Pressure Level (H / M / S / SL)	dB(A)	38 / 31 / 26 / 20	38 / 31 / 26 / 20	39 / 31 / 26 / 20	43 / 36 / 29 / 22
	Fan Motor Output	W	38	38	38	38
	Unit Dimension (WxHxD)	in (mm)	23 x 30 x 8 (590 x 750 x 215)	23 x 30 x 8 (590 x 750 x 215)	23 x 30 x 8 (590 x 750 x 215)	23 x 30 x 8 (590 x 750 x 215)
	Net / Gross Weight	lbs (kg)	33 / 37 (15 / 17)	33 / 37 (15 / 17)	33 / 37 (15 / 17)	33 / 37 (15 / 17)
	Air Direction Control		Vertical/-	Vertical/-	Vertical/-	Vertical/-
	Front Panel Color		ShadowWhite (5PB8.7/0.5)			
Piping Connections	Liquid	in (mm)	1/4 (6.35)	1/4 (6.35)	1/4 (6.35)	1/4 (6.35)
	Gas	in (mm)	3/8 (9.52)	3/8 (9.52)	3/8 (9.52)	1/2 (12.7)
	Drain	in (mm)	5/8 (15.87)	5/8 (15.87)	5/8 (15.87)	5/8 (15.87)
Option	Wi-Fi (Adapter Required)		Optional	Optional	Optional	Optional

M400 MULTI-ZONE SYSTEM

Please refer to Product submittals for gas/liquid lines port sizes.

Test conditions are based on AHRI 210/240. *1. Rating conditions (cooling) – Indoor: D.B. 80° F (27° C), W.B. 67° F (19° C); Outdoor: D.B. 95° F (35° C), W.B. 75° F (24° C).

Rating conditions (heating) – Indoor* D.B. 70° F (21° C), W.B. 60° F (16° C); Outdoor: D.B. 47° F (8° C), W.B. 43° F (6° C).

Specifications are subject to change without notice. Manufacturer reserves the right to discontinue or change at any time, specifications or designs without notice or without incurring obligations.

M400 MULTI-ZONE SYSTEM INDOOR UNITS

M400 Ducted Indoor Unit

- Optional Wi-Fi Capability
- Eco Mode Fixed
- Internal condensate drain pump
- Medium static pressure capability



Model	Ducted Indoor		RAD-SH07QHAE	RAD-SH09QHAE	RAD-SH12QHAE	RAD-SH18QHAE	RAD-SH24QHAE
	System Type		Heat Pump	Heat Pump	Heat Pump	Heat Pump	Heat Pump
Performance	Capacity	BTU / h	7000 (3050 - 8500)	9000 (3050 - 10200)	12000 (3050 - 13650)	18000 (4100 - 19800)	24000 (4100 - 25600)
Power Supply	Rated Voltage	V / Ph / Hz	208/230/ 1 / 60	208/230/ 1 / 60	208/230/ 1 / 60	208/230/ 1 / 60	208/230/ 1 / 60
Specifications	Airflow (H / M / L / SL)	CFM	300 / 264 / 229 / 194	300 / 264 / 229 / 194	300 / 264 / 229 / 194	671 / 470 / 317 / 206	671 / 470 / 317 / 206
	Fan Motor Output	W	20	20	20	180	180
	Fan Speed	Steps	4	4	4	4	4
	External Static Pressure	inAq (Pa)	0.3 (70)	0.3 (70)	0.3 (70)	0.6 (150)	0.6 (150)
	Cooling Sound Pressure Level (H / M / S / SL)	dB(A)	41/37/33/30	41/37/33/30	41/37/33/20	39/35/32/29	39/35/32/29
	Heating Sound Pressure Level (H / M / S / SL)	dB(A)	42/38/34/30	42/38/34/30	42/38/34/30	40/35/32/29	40/35/32/29
	Unit Dimension (WxHxD)	in (mm)	9x29x15 (235x750x400)	9x29x15 (235x750x400)	9x29x15 (235x750x400)	10x35x28 (270x900x720)	10x35x28 (270x900x720)
	Net / Gross Weight	lbs (kg)	35 / 40 (16 / 18)	35 / 40 (16 / 18)	35 / 40 (16 / 18)	77 / 86 (25 / 39)	77 / 86 (25 / 39)
	Air Filter		Normal	Normal	Normal	Normal	Normal
Piping Connections	Liquid	in (mm)	1/4 (6.35)	1/4 (6.35)	1/4 (6.35)	1/4 (6.35)	1/4 (6.35)
	Gas	in (mm)	3/8 (9.53)	3/8 (9.525)	3/8 (9.525)	1/2 (12.7)	1/2 (12.7)
	Drain	in (mm)	5/8 (15.87)	5/8 (15.87)	5/8 (15.87)	5/8 (15.87)	5/8 (15.87)
Option	Wi-Fi (Adapter Required)		Optional	Optional	Optional	Optional	Optional

Please refer to Product submittals for gas/liquid lines port sizes.

Test conditions are based on AHRI 210/240. *1. Rating conditions (cooling) – Indoor: D.B. 80° F (27° C), W.B. 67° F (19° C); Outdoor: D.B. 95° F (35° C), W.B. 75° F (24° C).

Rating conditions (heating) – Indoor* D.B. 70° F (21° C), W.B. 60° F (16° C); Outdoor: D.B. 47° F (8° C), W.B. 43° F (6° C).

Specifications are subject to change without notice. Manufacturer reserves the right to discontinue or change at any time, specifications or designs without notice or without incurring obligations.



MINI-SPLIT SYSTEMS

M400 MULTI-ZONE SYSTEM



Outdoor / Indoor Unit Combinations

M400 SERIES MULTI-ZONE SYSTEM OPTIONS POSSIBLE OUTDOOR / INDOOR COMBINATIONS - 18-24K

MINI-SPLIT SYSTEMS

Outdoor Unit Model	2-Zone
18K	7k+7k
	7k+9k
	7k+12k
	9k+9k
	9k+12k
	12k+12k

Outdoor Unit Model	2-Zone	3-Zone
24K	7K+7K	7K+7K+7K
	7K+9K	7K+7K+9K
	7K+12K	7K+7K+12K
	7K+18K	7K+7K+18K
	9K+9K	7K+9K+9K
	9K+12K	7K+9K+12K
	9K+18K	7K+9K+18K
	12K+12K	7K+12K+12K
	12K+18K	9K+9K+9K
	18K+18K	9K+9K+12K
		9K+9K+18K
		9K+12K+12K
	12K+12K+12K	

OUTDOOR/INDOOR UNIT COMBINATIONS

Outdoor / Indoor Unit Combinations

M400 SERIES MULTI-ZONE SYSTEM OPTIONS POSSIBLE OUTDOOR / INDOOR COMBINATIONS - 36K

Outdoor Unit Model	2-Zone	3-Zone	4-Zone
36K	7K+7K	7K+7K+7K	7K+7K+7K+7K
	7K+9K	7K+7K+9K	7K+7K+7K+9K
	7K+12K	7K+7K+12K	7K+7K+7K+12K
	7K+18K	7K+7K+18K	7K+7K+7K+18K
	7K+24K	7K+7K+24K	7K+7K+7K+24K
	9K+9K	7K+9K+9K	7K+7K+9K+9K
	9K+12K	7K+9K+12K	7K+7K+9K+12K
	9K+18K	7K+9K+18K	7K+7K+9K+18K
	9K+24K	7K+9K+24K	7K+7K+9K+24K
	12K+12K	7K+12K+12K	7K+7K+12K+12K
	12K+18K	7K+12K+18K	7K+7K+12K+18K
	12K+24K	7K+18K+18K	7K+9K+9K+9K
	18K+18K	7K+12K+24K	7K+9K+9K+12K
	18K+24K	9K+9K+9K	7K+9K+9K+18K
	24K+24K	9K+9K+12K	7K+9K+12K+12K
		9K+9K+18K	7K+9K+12K+18K
		9K+9K+24K	7K+12K+12K+12K
		9K+12K+12K	9K+9K+9K+9K
		9K+12K+18K	9K+9K+9K+12K
		9K+12K+24K	9K+9K+9K+18K
		9K+18K+18K	9K+9K+12K+12K
		12K+12K+12K	9K+9K+12K+18K
		12K+12K+18K	9K+12K+12K+12K
		12K+12K+24K	12K+12K+12K+12K
		12K+18K+18K	

Outdoor / Indoor Unit Combinations

M400 SERIES MULTI-ZONE SYSTEM OPTIONS POSSIBLE OUTDOOR / INDOOR COMBINATIONS - 42K

MINI-SPLIT SYSTEMS

Outdoor Unit Model	2-Zone	3-Zone	4-Zone	5-Zone	
42K	7K+7K	7K+7K+7K	7K+7K+7K+7K	7K+7K+7K+7K+7K	
	7K+9K	7K+7K+9K	7K+7K+7K+9K	7K+7K+7K+7K+9K	
	7K+12K	7K+7K+12K	7K+7K+7K+12K	7K+7K+7K+7K+12K	
	7K+18K	7K+7K+18K	7K+7K+7K+18K	7K+7K+7K+7K+18K	
	7K+24K	7K+7K+24K	7K+7K+7K+24K	7K+7K+7K+7K+24K	
	9K+9K	7K+9K+9K	7K+7K+9K+9K	7K+7K+7K+9K+9K	
	9K+12K	7K+9K+12K	7K+7K+9K+12K	7K+7K+7K+9K+12K	
	9K+18K	7K+9K+18K	7K+7K+9K+18K	7K+7K+7K+9K+18K	
	9K+24K	7K+9K+24K	7K+7K+9K+24K	7K+7K+7K+9K+24K	
	12K+12K	7K+12K+12K	7K+7K+12K+12K	7K+7K+7K+12K+12K	
	12K+18K	7K+12K+18K	7K+7K+12K+18K	7K+7K+7K+12K+18K	
	12K+24K	7K+12K+24K	7K+7K+12K+24K	7K+7K+7K+12K+24K	
	18K+18K	7K+18K+18K	7K+7K+18K+18K	7K+7K+7K+18K+18K	
	18K+24K	7K+18K+24K	7K+7K+18K+24K	7K+7K+9K+9K+9K	
	24K+24K	7K+24K+24K	7K+9K+9K+9K	7K+7K+9K+9K+12K	
			9K+9K+9K	7K+9K+9K+12K	7K+7K+9K+9K+18K
			9K+9K+12K	7K+9K+9K+18K	7K+7K+9K+9K+24K
			9K+9K+18K	7K+9K+9K+24K	7K+7K+9K+12K+12K
			9K+9K+24K	7K+9K+12K+12K	7K+7K+9K+12K+18K
			9K+12K+12K	7K+9K+12K+18K	7K+7K+9K+12K+24K
			9K+12K+18K	7K+9K+12K+24K	7K+7K+9K+18K+18K
			9K+12K+24K	7K+9K+18K+18K	7K+7K+12K+12K+12K
			12K+12K+12K	7K+9K+18K+24K	7K+7K+12K+12K+18K
			12K+12K+18K	7K+12K+12K+12K	7K+9K+9K+9K+9K
			12K+12K+24K	7K+12K+12K+18K	7K+9K+9K+9K+12K
			12K+18K+18K	7K+12K+12K+24K	7K+9K+9K+9K+18K
			12K+18K+24K	7K+12K+18K+18K	7K+9K+9K+9K+24K

OUTDOOR/INDOOR UNIT COMBINATIONS

Table is continued on the next page.

Outdoor / Indoor Unit Combinations

M400 SERIES MULTI-ZONE SYSTEM OPTIONS POSSIBLE OUTDOOR / INDOOR COMBINATIONS - 42K

Table is continued from previous page.

Outdoor Unit Model	2-Zone	3-Zone	4-Zone	5-Zone
42K		12K+24K+24K	9K+9K+9K+9K	7K+9K+9K+12K+12K
			9K+9K+9K+12K	7K+9K+9K+12K+18K
			9K+9K+9K+18K	7K+9K+12K+12K+12K
			9K+9K+9K+24K	7K+9K+12K+12K+18K
			9K+9K+12K+12K	7K+12K+12K+12K+12K
			9K+9K+12K+18K	9K+9K+9K+9K+9K
			9K+9K+12K+24K	9K+9K+9K+9K+12K
			9K+9K+18K+18K	9K+9K+9K+9K+18K
			9K+9K+18K+24K	9K+9K+9K+9K+24K
			9K+12K+12K+12K	9K+9K+9K+12K+12K
			9K+12K+12K+18K	9K+9K+9K+12K+18K
			9K+12K+12K+24K	9K+9K+12K+12K+12K
			9K+12K+18K+18K	9K+9K+12K+12K+18K
			12K+12K+12K+12K	9K+12K+12K+12K+12K
			12K+12K+12K+18K	
			12K+12K+12K+24K	
			12K+12K+18K+18K	



MINI-SPLIT SYSTEMS

OUTDOOR/INDOOR UNIT COMBINATIONS

CONTROLLERS

WIRELESS AND WIRED CONTROLLERS

Wireless Remote Controllers

Wireless remote controllers come standard with all single-zone series mini-split systems. A remote control option is available for our multi-zone system.

These units provide precise control over system functions including:

- Programmed temperature control
- Louver position
- Timers
- Powerful mode
- Leave Home mode
- Eco mode
- Silent mode



MODEL RAR-MOB5
Comes standard with H300 Series



MODEL RAR-MOB6
Comes standard with H500 Series



MODEL RAR-MOB3
Comes standard with M400
Cassette and Floor Units



MODEL RAR-MOB4
Optional for M400
Ducted Units

Wired Controllers

Enjoy precise control over system functions including:

- Temperature
- Current operating mode
- Timer
- Louver position
- Silent mode

Additional functions available with SPX-WKT4:

- Powerful mode
- Leave Home mode
- Programmed temperature control
- Eco mode



MODEL SPX-WKT4
Control up to 13 indoor units, adapter SPX-DST1 required



MODEL SPX-RCDA1
Comes standard with M400 ducted units



MODEL SPX-RCDB1
Optional for all indoor Units except M400 Ducted Units



airCloud Home App

Control is just a click away with the airCloud Home app:

- Anytime, anywhere control
- User-friendly interface
- Set and change schedules for maximum energy savings
- Fully compatible with Amazon Alexa and Google Assistant



airCloud Home Adapter
MODEL: RA-SPX-WFA
Required for H300 Series.

Wired Central Controller

Enjoy precise control over multiple units with this intuitive color touchscreen controller:

- Schedule operations
- Set temperature range remotely
- View status of all groups
- View condition of all units
- Monitor alarms
- Manage maintenance and repairs with special service menu



MODEL CCL01



H-Link Gateway
MODEL: PSC-6RAD
Connect up to 128 units to be controlled using a central controller.

Controller feature comparison

Controller Type	STANDARD CONTROLLERS				OPTIONAL CONTROLLERS			
	Wireless Remote Controller	Advanced Wireless Remote Controller	Wired Remote Controller	Wireless Remote Controller	Wireless Remote Controller	Wired Remote Controller	Advanced Wired Remote Controller	Central Controller
Series	H300	H500, H700	M400 Ducted	M400 Cassette and Floor	M400 Ducted	H300, H500, H700, M400, Floor and Cassette	H300, H500, H700, M400	H300, H500, H700, M400
MODEL	RAR-M0B5	RAR-M0B6	SPX-RCDA1	RAR-M0B3	RAR-M0B4	SPX-RCDB1	SPX-WKT4	CCL01
								
Temperature	*	*	*	*	*	*	*	*
Fan Speed	*	*	*	*	*	*	*	*
Louver Position	*	*		*		*	*	
Timer	*	*	*	*	*	*	*	
Sleep Timer	*		*	*	*	*	*	
Eco Mode	*	*		*	*		*	
Powerful Operation	*	*		*	*		*	
Leave Home	*	*		*	*		*	
Silent	*	*	*	*	*	*	*	
Clean	*	*		*	*		*	
FrostWash	*	*					*	
Dehumidy	*	*	*	*	*		*	*
Air Sleep		*						
Remote Control Temperature Sensors		*						
Operating Mode Lock		*	*			*	*	
Weekly Programmable		*					*	
Touch Screen								*
Holiday Setting							*	*
Daylight Savings Time							*	*

MINI-SPLIT SYSTEMS

CONTROLLERS



WE SUPPORT YOU EVERY STEP OF THE WAY

Expect consistent on-time deliveries

Ample inventory, advanced order management, and logistics systems ensure you get the right equipment to the job site on time, helping you complete installations in a timely manner. Our state-of-the art main distribution center is located in Memphis, Tennessee where UPS and FedEx have hubs. This enables us to provide fast, accurate deliveries and simplifies expedited shipments. Consistent service and predictable deliveries help you prevent delays and enable you to set a project timeline and schedule labor efficiently.



MINI-SPLIT SYSTEMS

You're covered with industry-leading warranties

Enjoy the best protection in the industry with our factory-backed warranties. In addition to the standard 7-year limited compressor and 5-year limited parts warranty, we offer an enhanced warranty that provides protection for 10 years.

Simply register the system on HVACNavigator.com for an automatic upgrade to a 10-year parts and 10-year compressor warranty. And enjoy unparalleled support with our 10-year labor plans.

STANDARD WARRANTY



EXTENDED WARRANTY



Requires online registration. Available for installations in residential applications at no additional cost.

EXTENDED WARRANTY WITH LABOR

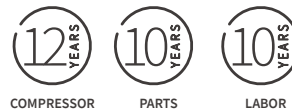

Requires online registration and purchase of warranty upgrade. Available for installations in residential applications.

SUPPORT



We'll get your team up to speed quickly

Effective training, intuitive design and selection software, advanced logistics and delivery, and easily accessible documentation form a powerful support package that adds substantial value to Hitachi Mini-Split Systems. Comprehensive installation and startup classes provide the skills necessary to install Hitachi Mini-Split Systems effectively and efficiently.

Our training centers are located in Dallas, Texas and New Freedom, Pennsylvania. They include laboratories with multiple mini-split systems to provide hands-on

experience with components and controls. Videos and webinars supplement classroom learning on specific subjects that refresh and enhance the skills of your sales, design, installation, and service teams. Hitachi ductless mini-split system training helps deliver the peace of mind that your staff is prepared to support your business with the knowledge to compete in a growing industry.

Selection is simple

The online program allows access from any computer or tablet. The software's intuitively designed features and functionality enable you to:

- Select options and accessories quickly, easily and accurately without the need for additional information or calculations.
- Gain an edge by confidently and easily designing mini-split systems.
- Work efficiently by providing quick access to accurate product information.





Johnson Controls-Hitachi Air Conditioning North America

CUSTOMER SERVICE

844-873-4445 Option 1
BE-VRFCustomerService@jci-hitachi.com

The specifications of this catalog may change without prior notice to allow Hitachi Cooling & Heating to incorporate the latest innovations for its customers. The information contained in this catalog is merely informative. Hitachi Cooling & Heating declines any responsibility in the broadest sense, for damage, direct or indirect, arising from the use and / or interpretation of the recommendations in this catalog. Additional Information

Before purchasing this appliance, read important information about its estimated annual energy consumption, yearly operating cost, or energy efficiency rating that is available from your retailer.

HITACHI. CERTIFIED QUALITY



Industry certified

Hitachi mini-split systems are certified by the Air Conditioning, Heating & Refrigeration Institute. The systems are also UL certified. airCloud Home App is ETL certified (Canada & USA), signifying it complies with the standard of Heating and Cooling Equipment (ANSI/UL 1995 and CAN/CSA C22.2 No. 236-11, 4th Edition, October 14, 2011).

STANDARD WARRANTY



COMPRESSOR PARTS

EXTENDED WARRANTY



COMPRESSOR PARTS

Requires online registration. Available for installations in residential applications at no additional cost.

EXTENDED WARRANTY WITH LABOR



COMPRESSOR PARTS LABOR

Requires online registration and purchase of warranty upgrade. Available for installations in residential applications.

For more details on terms, conditions, and limitations, please refer to the warranty certificate. Contact your sales person or visit our warranty support center at BE-VRFWarranty@jci.com for specific eligibility requirements.

us.hitachiaircon.com

